

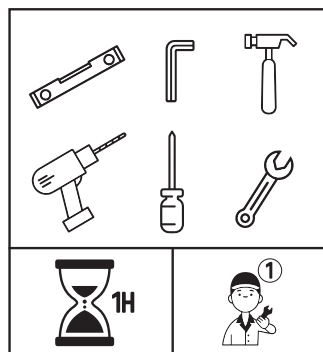

Des histoires de salle de bain

COL050



WWW.AURLANE.FR

 A lire obligatoirement avant installation 

- 1/ Les produits AURLANE sont **garantis 1 an pièces uniquement**. La main d'œuvre n'étant pas effectuée par nos soins, aucune garantie main d'œuvre ne sera appliquée par AURLANE. En cas de défaut de fabrication avéré ou de casse, ces éléments peuvent être commandés au distributeur ayant vendu ce produit, cependant en aucun cas la main d'œuvre relative à un remplacement de la pièce ne sera prise en charge par AURLANE.
- 2/ Il est indispensable de vérifier l'état de chacun des éléments au déballage. Aucune réclamation relative à la qualité du produit ne sera prise en compte passé un délai de 07 jours après l'achat du produit.
- 3/Ce produit doit être installé par un plombier qualifié afin d'éviter tout risque de malfaçon. Notre société décline toute responsabilité dans le cas où il serait installé par du personnel non qualifié.
- 4/ Attention à ne pas utiliser d'agents de nettoyage contenant de l'acétone, du chlore ou de l'eau ammoniacale (eau de javel). Toute utilisation d'un tel produit entraînerait automatiquement une détérioration rapide des éléments chromés (ex: buses de massage, robinetterie, douchette, profilés aluminium,.....)

DÉCLARATION DES PERFORMANCES

N o DoP_COL029 – COL060

1. Code d'identification unique du produit Type : COLONNES DE DOUCHE COL029 – COL060

2. Usage ou usages prévus du produit de construction, conformément à la spécification technique harmonisée applicable, comme prévu par le fabricant :

ROBINETTERIE SANITAIRE POUR HYGIENE PERSONNEL

3. Fabricant :

AURLANE 55 RUE LA CONDAMINE 75017 PARIS

4. Mandataire:

Non applicable

5. Système(s) d'évaluation et de vérification de la constance des performances :

Système 4

6a/ Norme harmonisée : EN200, EN817, EN1112, EN1113, EN13618_1, EN13618_1, EN13618_2, EN1250

Organisme notifié : Non applicable

6b/ Document d'évaluation européen : Non applicable

Evaluation technique européenne Non applicable
Organisme d'évaluation technique Non applicable
Organisme(s) notifié(s) Non applicable

7. Performances déclarées

Caractéristiques essentielles	Performances	Spécifications techniques harmonisées
Aptitude au nettoyage	Exigences satisfaites	EN200, EN817, EN1112, EN1113, EN13618_1, EN13618_1, EN13618_2, EN1250
Durabilité	Exigences satisfaites	EN200, EN817, EN1112, EN1113, EN13618_1, EN13618_1, EN13618_2, EN1250

Les performances du produit identifié ci-dessus sont conformes aux performances déclarées indiquées.

Conformément au règlement (UE) n°305/2011, la présente déclaration des performances est établie sous la seule responsabilité du fabricant mentionné ci-dessus.

Signé au nom du fabricant par :

Sébastien Doumenc
Directeur associé Aurlane
A Paris, le 01/01/2022



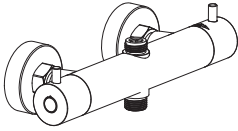

[01]x1
AURL1571



[02]x1
AURL1559



[03]x1
AURL1560



[04]x2
AURL1562



[05]x2
AURL1563



[06]x2
AURL1561



[07]x1
AURL1567



[08]x1
AURL1565



[09]x1
AURL1568



[10]x1
S2.5



[11]x1
AURL1564



[12]x1
AURL1569

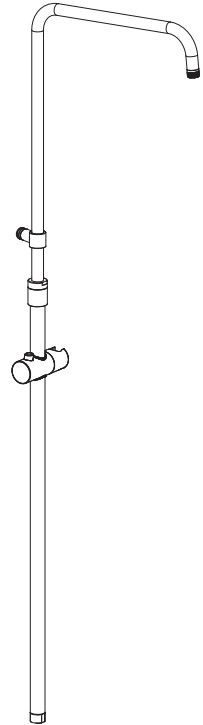

[13]x1
AURL1573

01



[04]x2
AURL1562

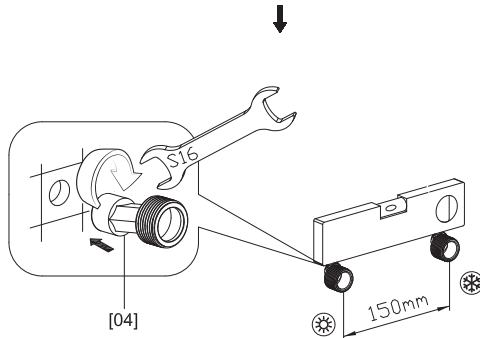
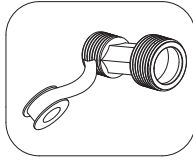

02



[05]x2
AURL1563

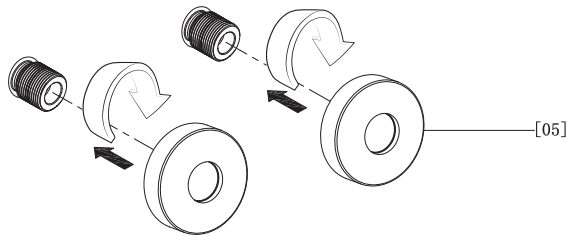

03



[06]x2
AURL1561

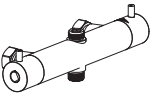

[01]x1
AURL1571

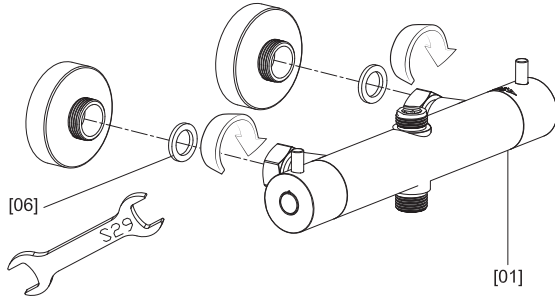

04

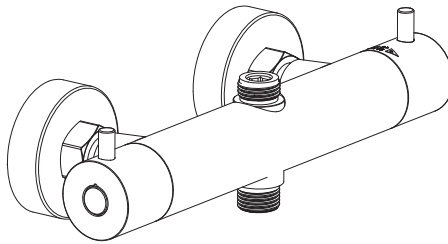

05



[07]x1
AURL1567



[10]x1

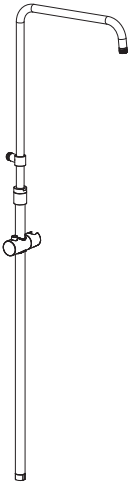

[13]x1
AURL1573



[12]x1
AURL1569

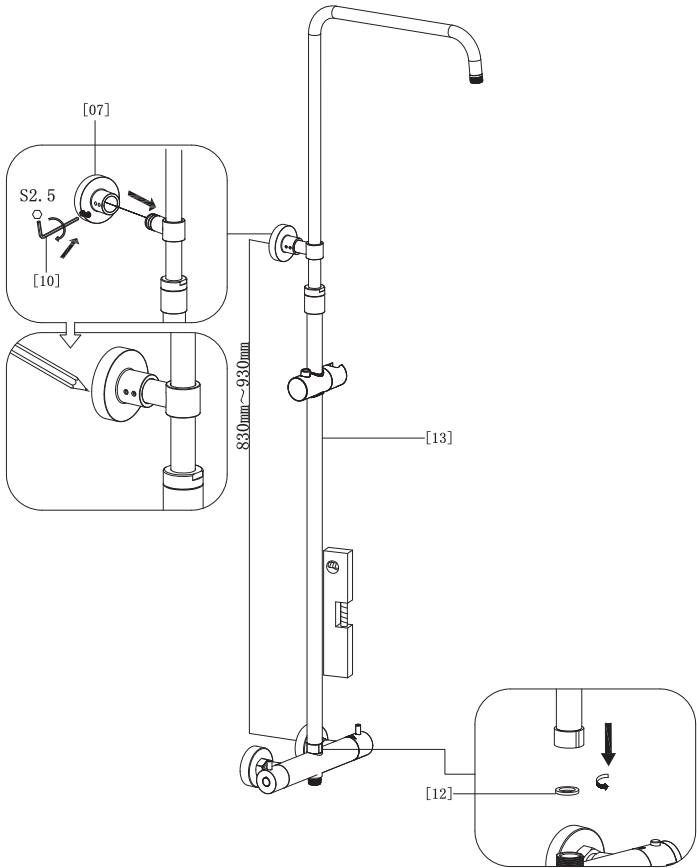

06

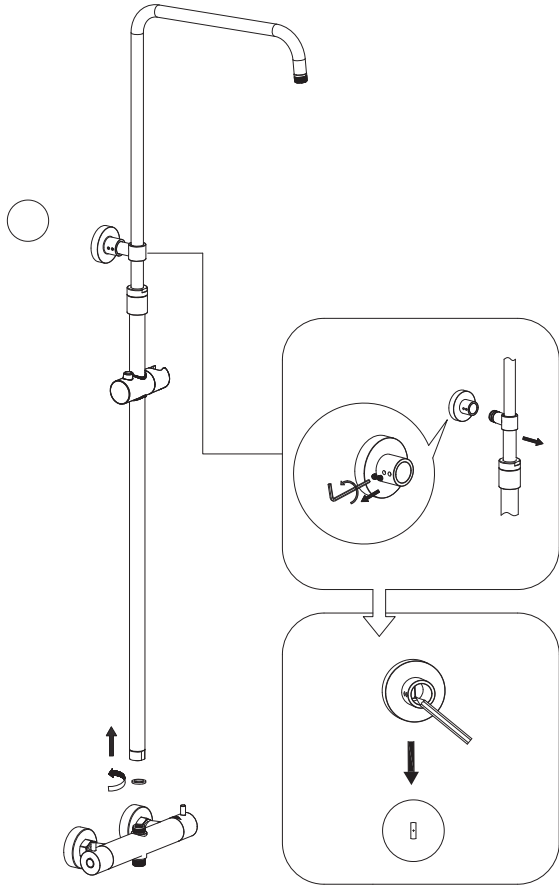

07



[02]x1
AURL1559



[03]x1
AURL1560

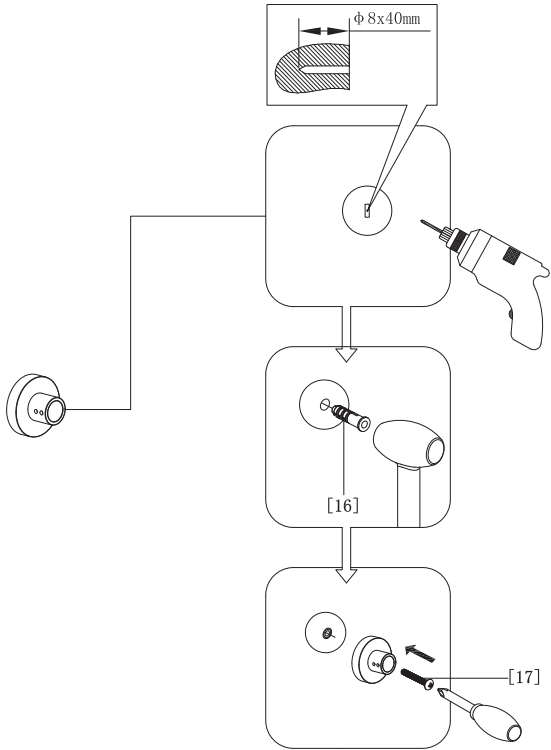

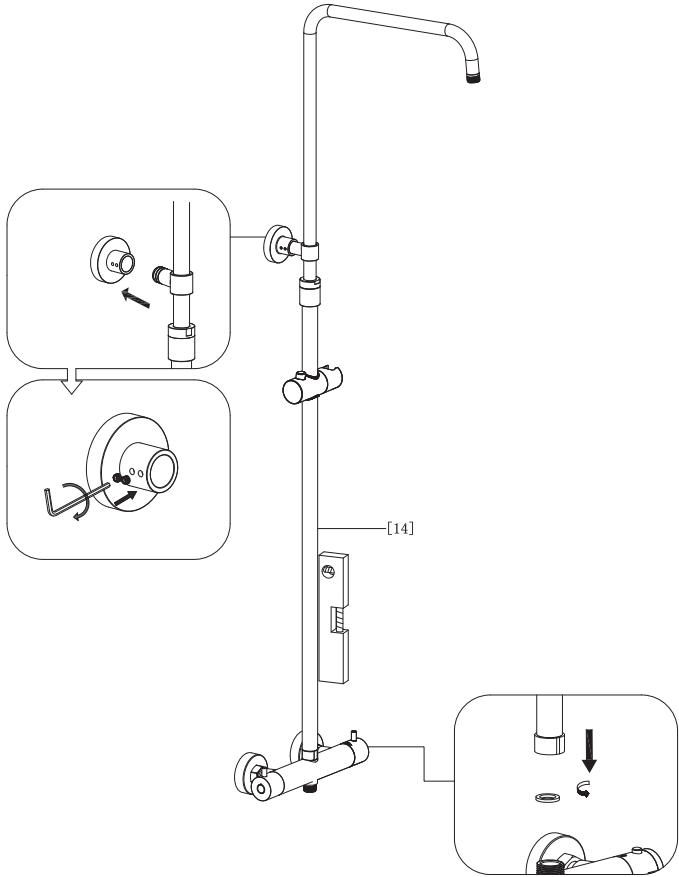

09



[08]x1
AURL1565

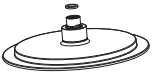

[09]x1
AURL1568

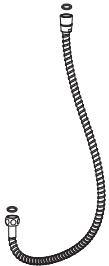

[11]x1
AURL1564

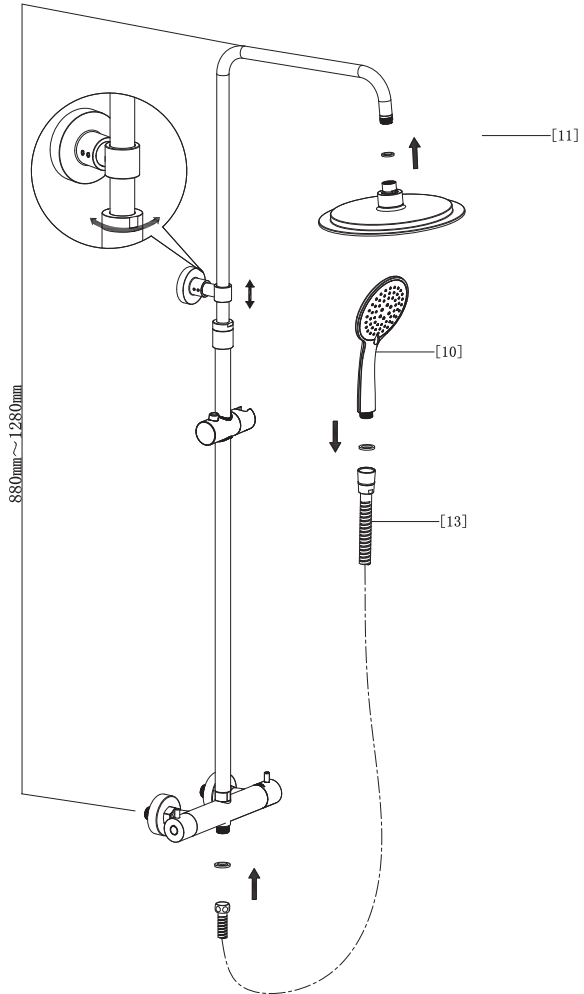

10

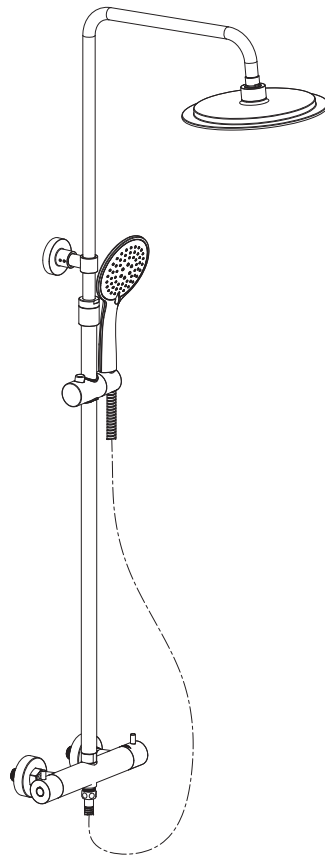



①

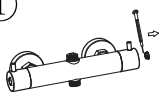

②



③



④

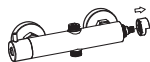

⑤

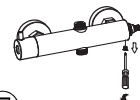

⑥



⑦



⑧



⑨

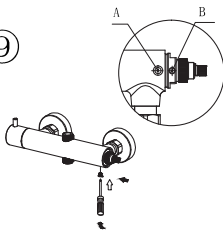

⑩

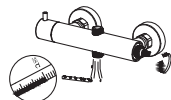

⑪

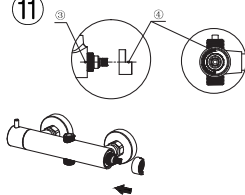

⑫



⑬



⑭



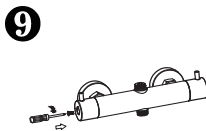
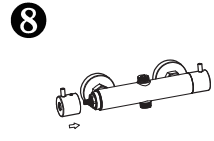
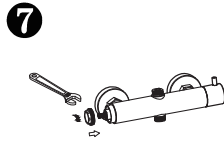
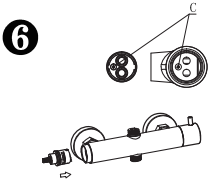
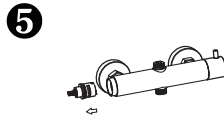
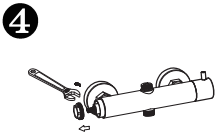
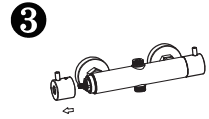
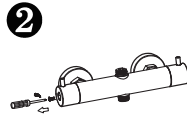
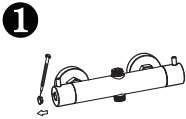

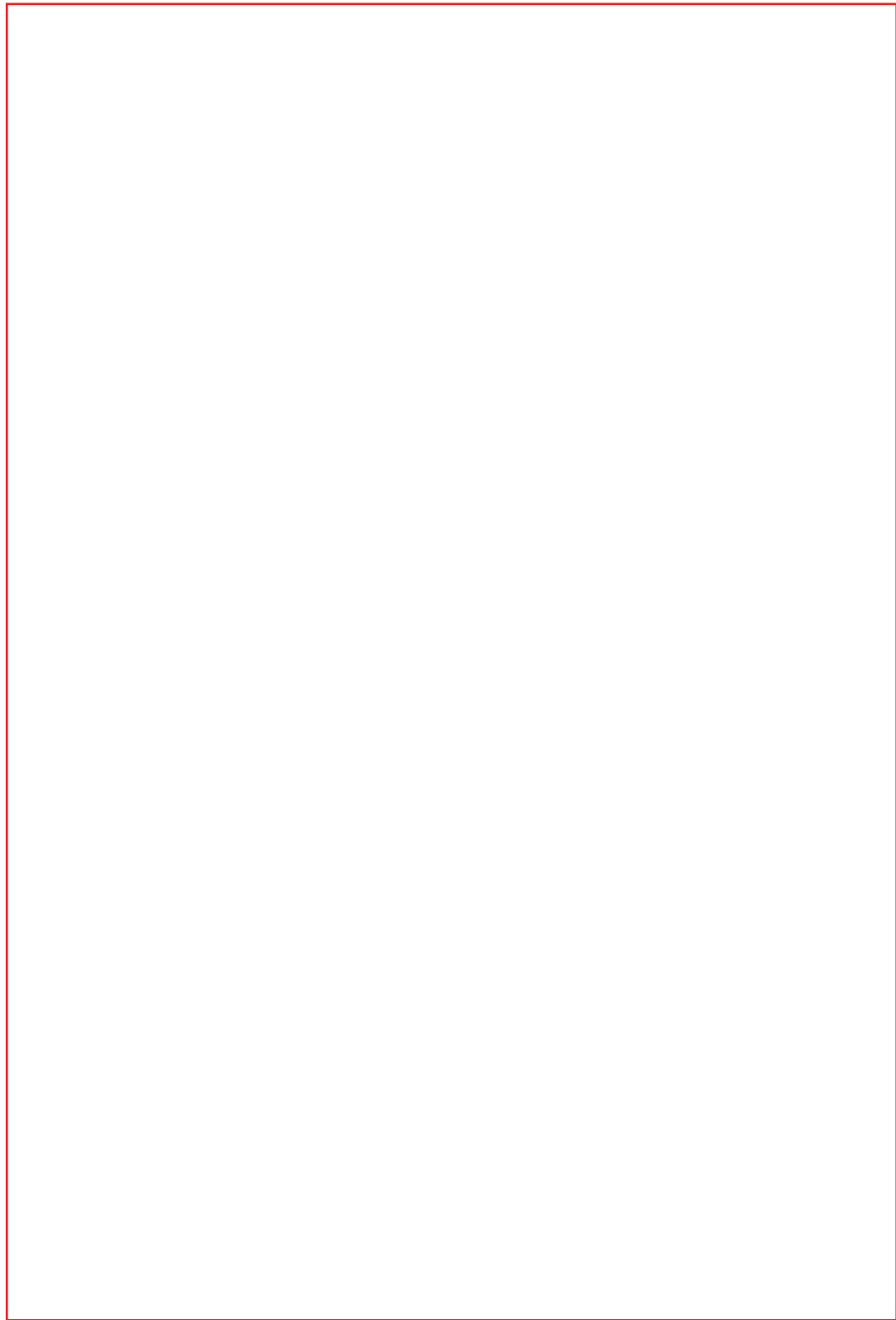



AURLANE

MERCI POUR VOTRE ACHAT !

Toute l'équipe Aurlane vous remercie de votre confiance.

Fabricant français depuis 2003, Aurlane met un point d'honneur à développer des produits modernes et design à des prix compétitifs pour permettre à tous nos clients d'avoir la salle de bains de leurs rêves.

Notre équipe SAV est disponible du lundi au vendredi, à l'adresse mail : web@aurlane.com

PARTAGEZ-NOUS VOTRE SALLE DE BAINS !

Suite à votre achat, envoyez-nous des photos et des vidéos de votre salle de bains avec vos produits Aurlane, en échange de cadeaux !

1



Prenez en photo
votre salle de bains

2



Scannez le QR Code
et remplissez le formulaire

3



Envoyez vos photos et
donnez-nous votre avis

EN - SHARE YOUR BATHROOM WITH US ! Send us photos and videos of your bathroom with Aurlane products, **in exchange for gifts.** 1) Take a picture of your bathroom 2) Scan the QR code and complete the form 3) Send ! Don't forget to let us know your customer opinion.

NL - DEEL UW BADKAMER MET ONS ! Stuur ons foto's en/ of video's van uw badkamer door met uw aangekochte Aurlane-producten **en krijg een geschenk.** 1) Maak een foto van uw badkamer 2) Scan de QR-code en vul het formulier in 3) Verstuur! Maak van de gelegenheid gebruik om ons uw mening te geven omtrent onze service en producten.

ES - ¡ COMPARTÉ FOTOS DE TU BAÑO CON NOSOTROS ! Después de tu compra, envíanos fotos o vídeos de tu baño con tus productos Aurlane, **y te mandamos regalos.** 1) Toma una foto de tu baño 2) Escanea el código QR y completa el formulario 3) Envíanos las fotos! Aprovecha para dejarnos tu opinión.

IT - CONDIVIDI CON NOI LE FOTO DEL TUO BAGNO ! Dopo il tuo acquisto, inviaci foto e video del tuo bagno con i tuoi prodotti Aurlane, **in cambio di regali.** 1) Scatta una foto del tuo bagno 2) Scansiona il QR Code e compila il form 3) Invia! Cogli l'occasione per lasciarci la tua opinione.

PT - PARTILHEM CONNOSCO A VOSSA CASA DE BANHO ! Após a sua compra, envie-nos fotos e vídeos da sua casa de banho com os seus produtos Aurlane, **em troca de prémios.** 1) Tire uma foto da sua casa de banho 2) Digitalize o Código QR e preencha o formulário 3) Envie! Aproveite a oportunidade para nos deixar a sua opinião.

DE - ZEIGEN SIE UNS IHR BADEZIMMER ! Schicken Sie uns nach dem Kauf Fotos und Videos von Ihrem Badezimmer mit den Aurlane-Produkten **und erhalten Sie dafür ein Geschenk.** 1) Machen Sie ein Foto von Ihrem Badezimmer. 2) Scannen Sie den QR-Code und füllen Sie das Formular aus. 3) Senden Sie uns das Foto! Nutzen Sie die Gelegenheit, um uns Ihre Meinung mitzuteilen.

Rejoignez la communauté Aurlane !

www.aurlane.fr



Join Aurlane's community !