

COLONNE DOTZ 150 LAV 663

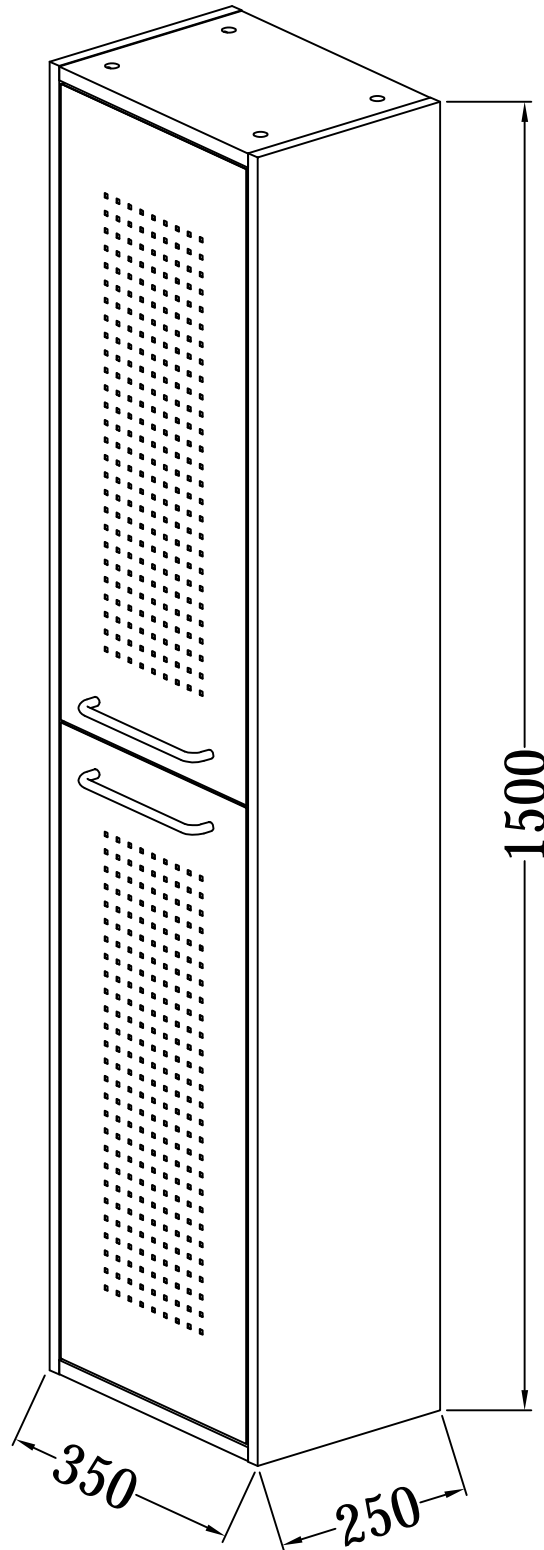

www.aurlane.fr

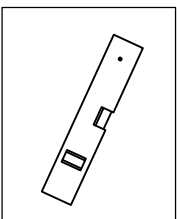
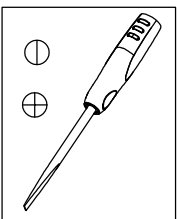
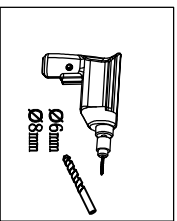
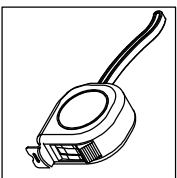
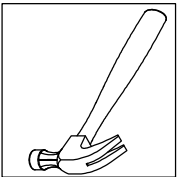
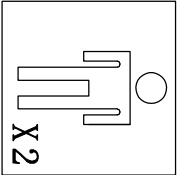
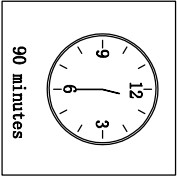

JS AURL1536 X1	AURL1517 DPZ M8x40 X2
AWGP AURL1536 X12	DG6 X2
SHV AURL1536 X12	
CBT AURL1536 X8	
TSK AURL1536 X12	
ZGLS-14 AURL1533 X6	
LS AURL1534 X2	
DW-35 AURL1535 X4	
SJT X2	

DOTZ 35-01

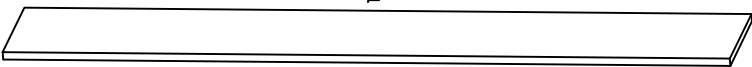

DOTZ 35-02

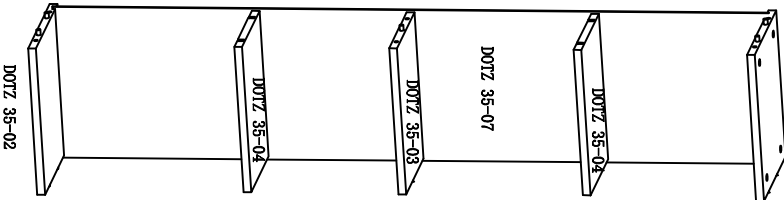

DOTZ 35-01

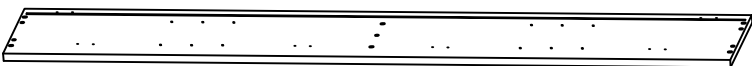

DOTZ 35-06

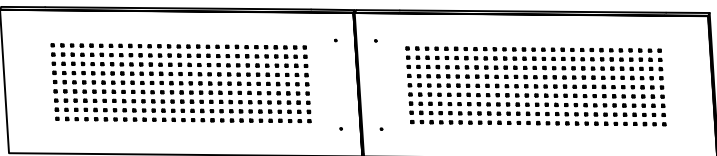

DOTZ 35-05

1

AURL1536



SHY

X 12

AURL1536

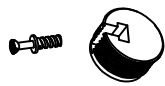

CBT

X 8

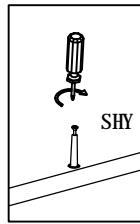

SHY

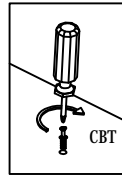

CBT

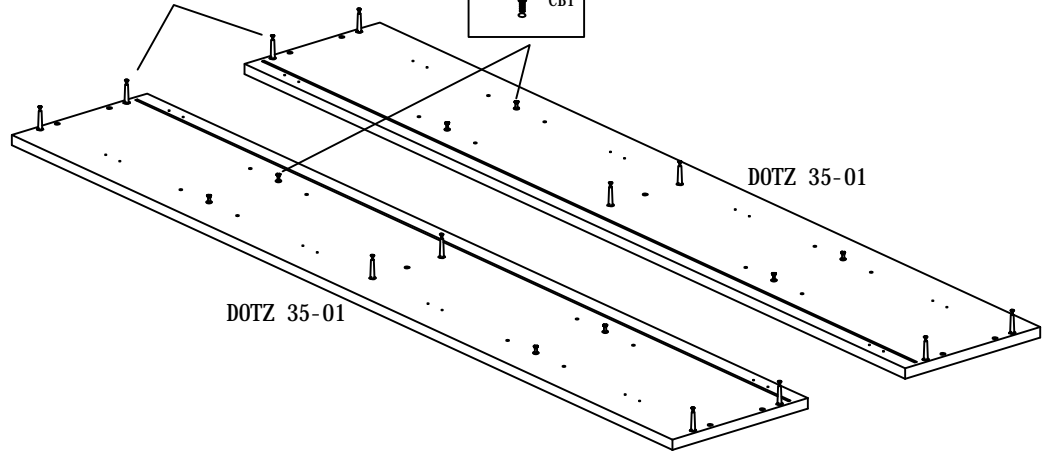

2

AURL1536



TSK

X 6

AURL1536



KWGP

X 6

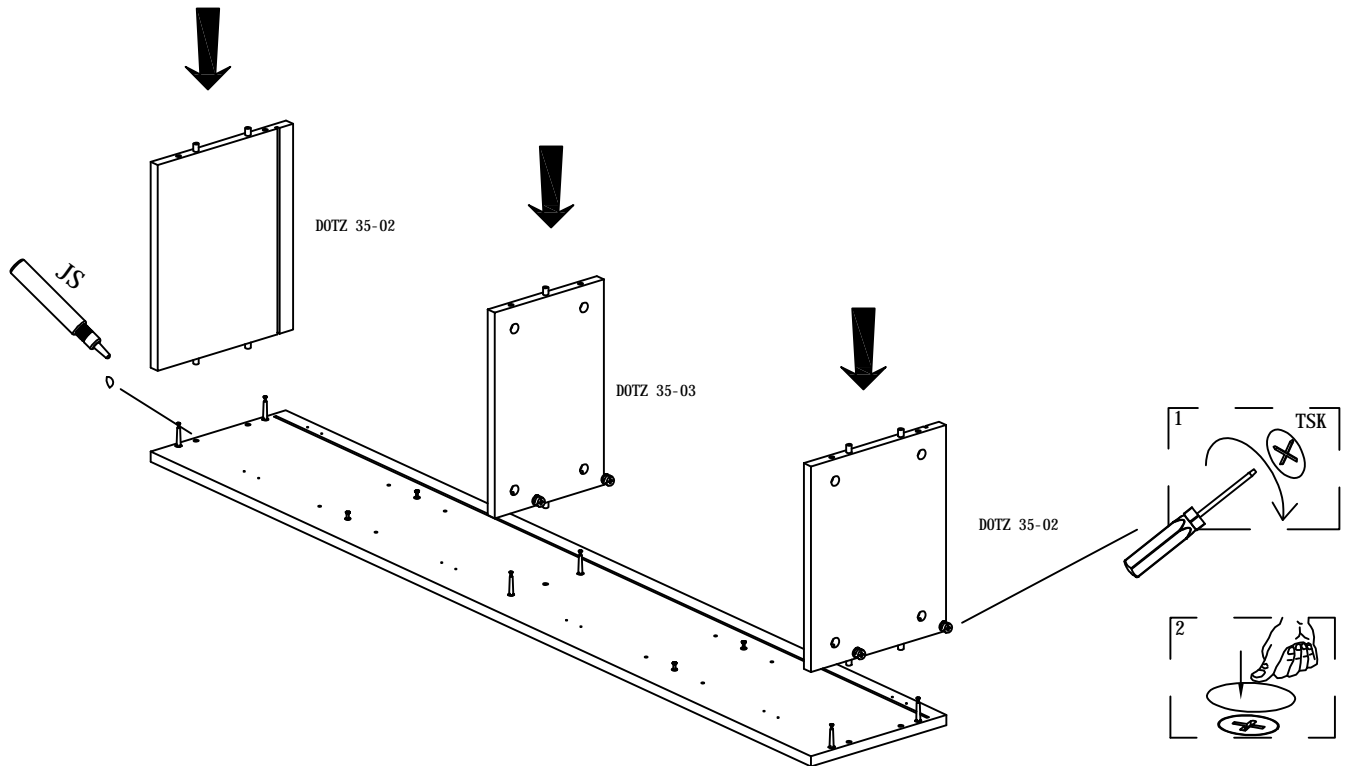

3

AURL1536



TSK

X 6

AURL1536



KWGP

X 6

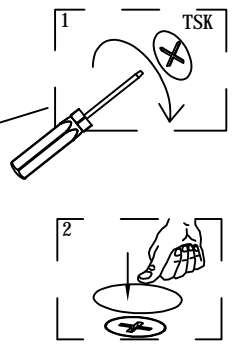
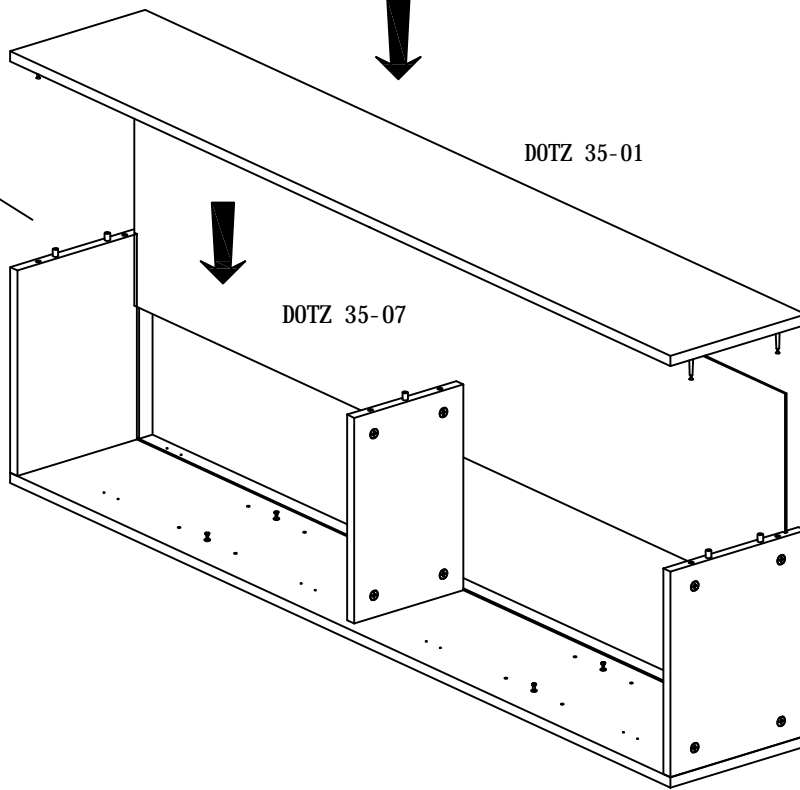
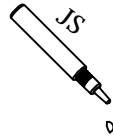

4

AURL1536



CBT

X 8

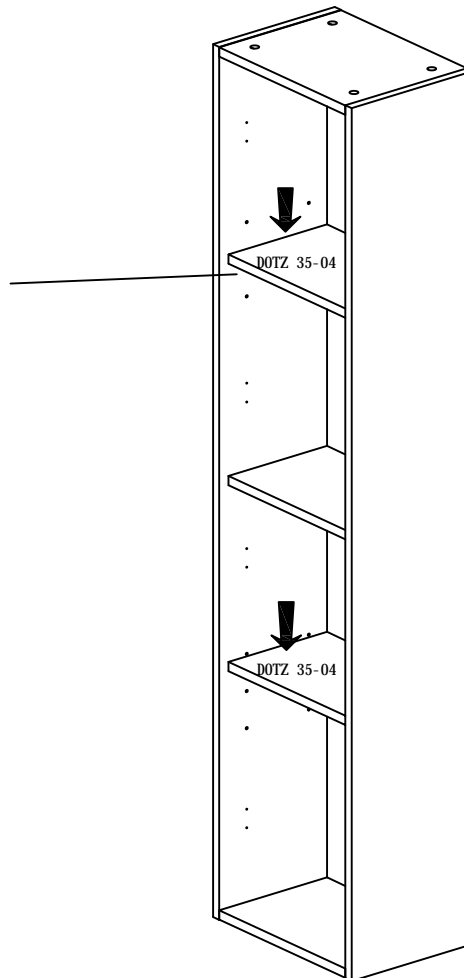
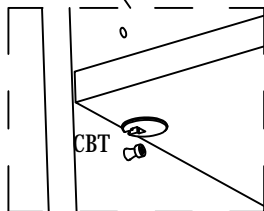
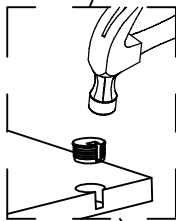
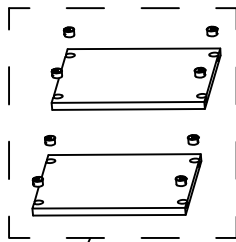

5

AURL1534



DW-35

X 4

AURL1533

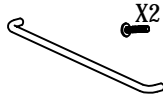

LS

X 2

AURL1535



SJT

X 2

AURL1536

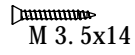

ZGLS-14

X 6

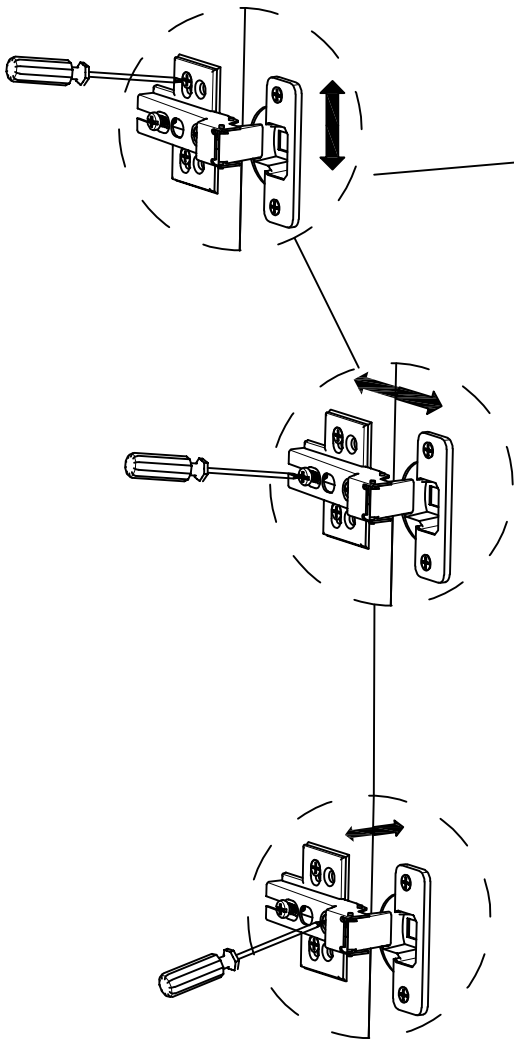

DOTZ 35-06

DOTZ 35-05

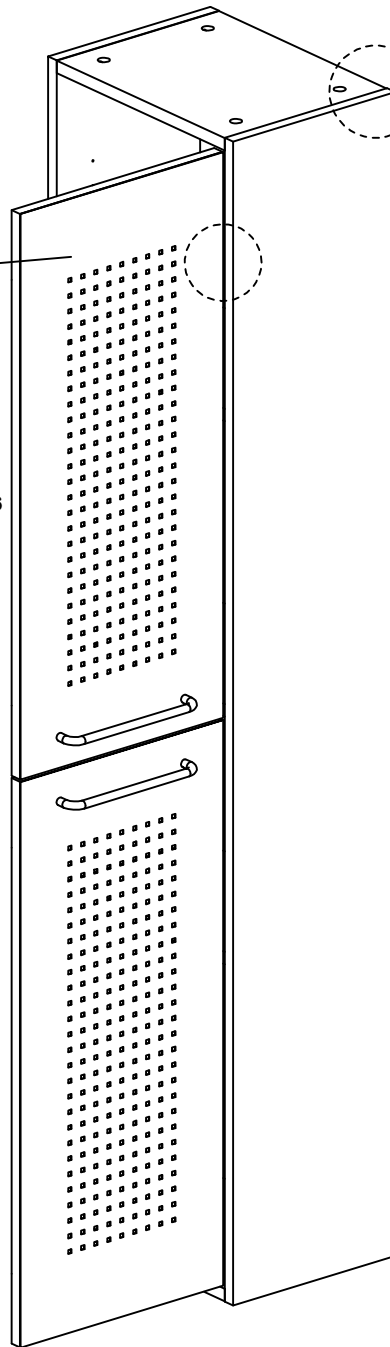
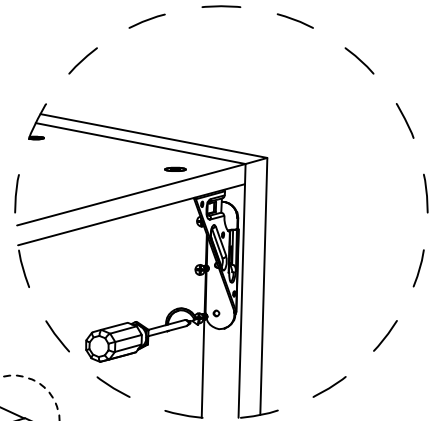

6

AURL1517



M8x40

DPZ

X 2

AURL1517

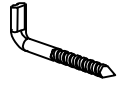

DGG

X 2

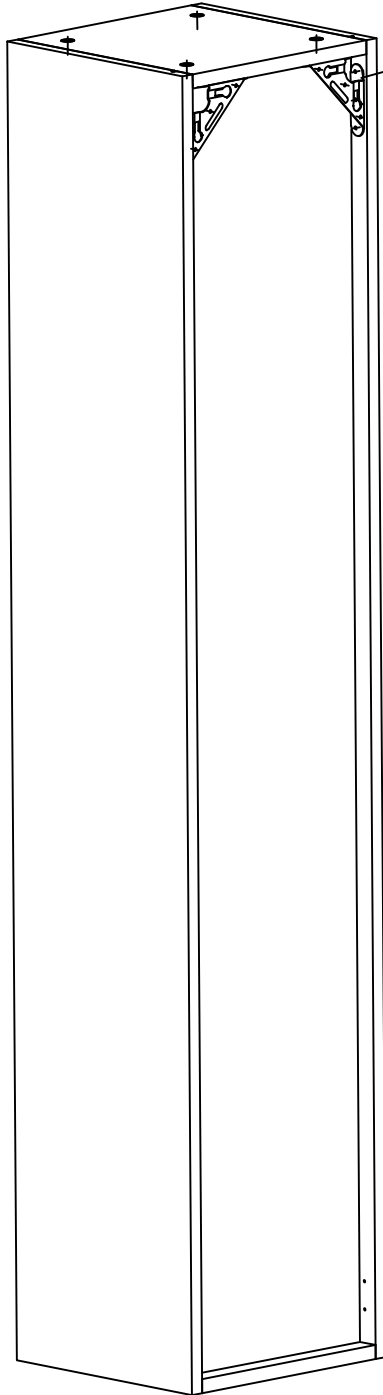

a

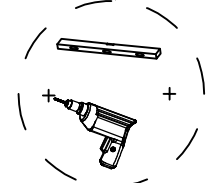

b

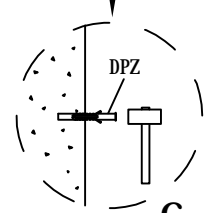

c

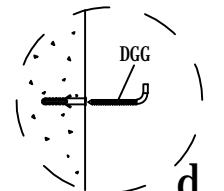

d

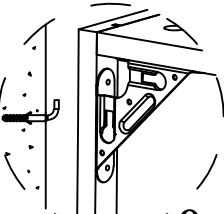

e

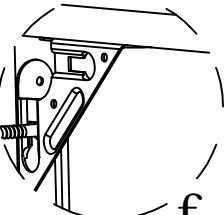

f